

# TKEY-1

**CW touch key**  
(no electromechanical contacts)

## Assembly manual

Last update: November 01, 2018

[ea3gcy@gmail.com](mailto:ea3gcy@gmail.com)

Updates and news at: [www.ea3gcy.com](http://www.ea3gcy.com)

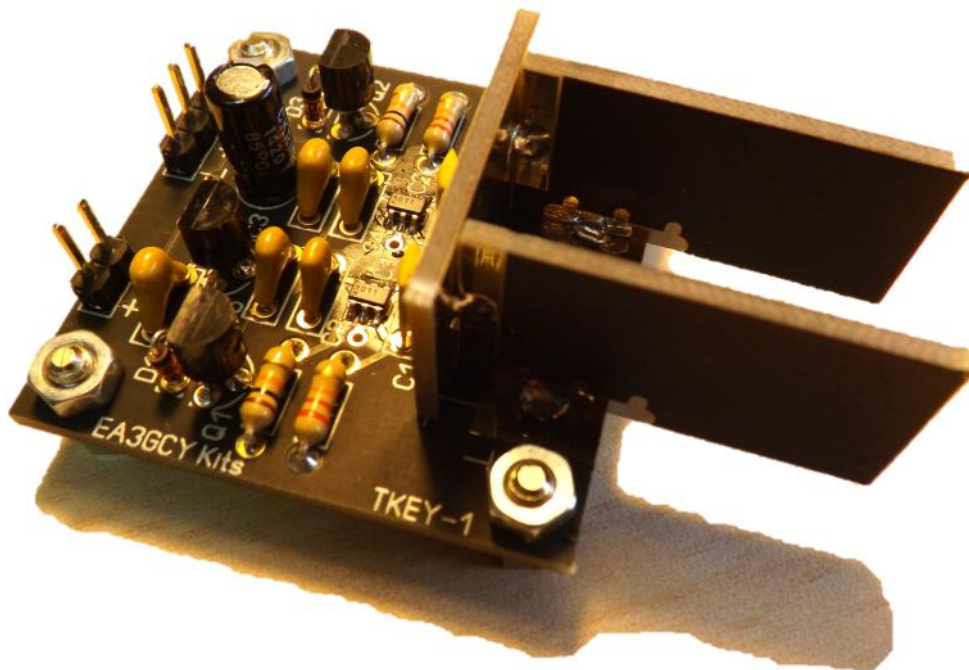

Thanks for constructing the **TKEY-1A** CW touch key

Have fun assembling it and enjoy QRP! 73 Javier Solans, ea3gcy

# SPECIFICATIONS

- **Keying:** touch-surface actuated.
- **Sensing mode:** capacitive.
- **Outputs:** L and R from transistors using open collector.
- **Power supply:** 7-15VDC < 15 mA consumption (modifiable optional battery 3 or 3,6V about 1,5mA see pag. 8)
- **Calibration:** self-calibrating at power-up.
- **It is not affected by humidity, dryness or dirt.**
- **Ideal for custom designed paddles.**
- **Printed circuit board dimensions:** 40 x 40 mm
- **Box size:** 57 x 76 x 25 mm
- SMD components are pre-installed.
- **Kit includes main board, boards for the paddles, and components (box not included).**

# PARTS LIST

Electronic components						
	Quantity	Reference	Value	Component type	Identification	
	2	R1, R2	22K	1/4W resistors	red-red-orange	
	2	R3, R4	10K	1/4W resistors	brown-black-orange	
	2	C1, C2	2n2	2200pF capacitors	0.022, 2n2, 2K2 or 222K	
	5	C3, C4, C5, C6, C8	100nf	100nF capacitors	104 or 0.1	
	1	C7	10uf	electrolytic capacitor	10uF	
	3	D1, D2, D3	1N4148	diodes	4148	
	2	Q1, Q2	BC547	NPN transistors	BC547	
	1	IC3	78L05	5V regulator 78L05	78L05	
	1	IC1, IC2	AT42QT1011	Touch sensor IC (pre-installed)	AT42QT1011	
	5	Terminal-pins	--	Terminal-pins 3 + 2	--	
	1	TKEY-1 PCB set	--	3 boards set TKEY-1	--	

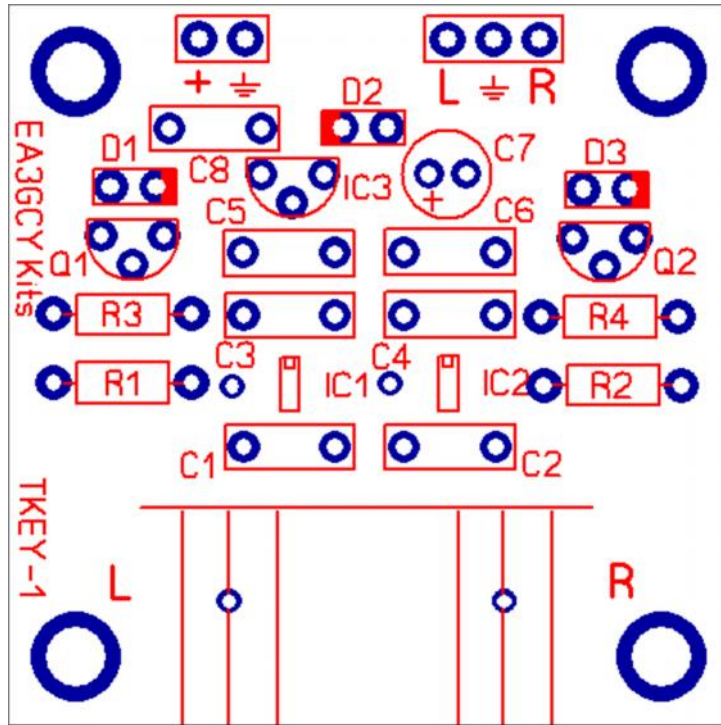

## TIPS FOR FIRST TIME BUILDERS

### Tools required:

- A 30W soldering iron, good-quality electronic-type solder, small diagonal wire cutters, needle-nose pliers, tweezers, screwdriver and a wrench for the nuts of the BNC connector and 2mm jacks (small adjustable wrench or 7mm and 4mm fixed wrenches).
- You will need good lighting and a magnifying glass to see the fine print on the components and other assembly details.

### Soldering:

There are two important things which need to be done to insure successful operation of a kit. The first is to put the component into the proper place on the circuit board; the second is good soldering.

To solder properly, you must use an electronic-type solder of the highest quality possible and the correct type of iron. Use a quality-brand soldering iron with a short, fine-pointed tip. For this kit, the soldering iron should be about 30-35 Watts (if it is not thermostatically controlled). Use only high-quality electronic-type solder. NEVER use any extra flux. You should hold the hot soldering iron in contact with both the circuit board and the component lead for about two seconds to heat them up. Then, keeping the soldering iron in place, touch the solder at the junction of the lead and trace and wait about two seconds or so until the solder flows between the lead and the trace to form a good joint. Now remove the soldering iron. The soldering iron should have been in contact with the work piece for a total time of about 4 seconds. When soldering leads that connect to large trace surfaces, you will need to preheat the junction for a little longer so that the solder flows correctly.

You should clean the soldering tip before soldering each joint. This prevents accumulating solder on the tip and mixing in residues from previous soldering operations with the next one.

# RECOMMENDED ASSEMBLY SEQUENCE

***Beware:*** If you are going to use the TKEY-1 with the "TKEY-1 BOX", you must bridge IC3 and D2 for the 3V - 3,6V supply (see "Installation in the TKEY-1 BOX")

## INSTALLING COMPONENTS

- 1.- Following to the parts list, place and solder resistors R1 through R4. Bend the leads so that the resistor can be easily placed on the board, with the component body touching the board.
- 2.- Following the parts list, place and solder the 2200pF capacitors C1 and C2, and the 100nF capacitors (marked 104) C3, C4, C5, C6 and C8 in their positions as printed on the board.
- 3.- Place and solder the 10uF electrolytic capacitor C7. The longer lead is the one that goes through the hole marked with a "+" on the board.
- 4.- Place and solder diodes D1, D2 and D3. These components are placed in a vertical position. They have a dark band around them that corresponds to the stripe printed on the board (see photos and board layout drawing). Before soldering them, make sure that they are placed in their correct position.
- 5.- Place and solder the BC547 transistors in their printed position on the board. Their component outline printed on the board should correspond to the component body.
- 6.- Place and solder the 5V regulator IC3 in its position according to the component outline on the circuit board.



- 7.- IC1 and IC2 are pre-installed. The board already has these components soldered.
- 8.- Place and solder the terminal pin headers. Turn the board upside down and solder them, securing them on the other side so that they don't fall out (use a tool to protect your fingers).

**Now you can power up the TKEY-1 and test it.**

# RECOMMENDATIONS

In high level RF environments, the TKEY-1 may suffer some faults.  
This happens rarely. But if happen, can observe the following recommendations:

- Install TKEY board in metallic enclosure
- Use battery. No external power supply.
- Use short audio coax cable from TKEY to Transceiver.
- Place RF choke in TKEY to Transceiver cable.
- In extreme case can try use opto-coupler circuit.

# POWER-UP AND MOUNTING THE PADDLES

Do not yet solder the pieces of circuit board that will be used as paddles.  
For the moment you can test it with your fingers directly touching the rectangular printed circuit board "islands" marked "L" and "R." See the photo:

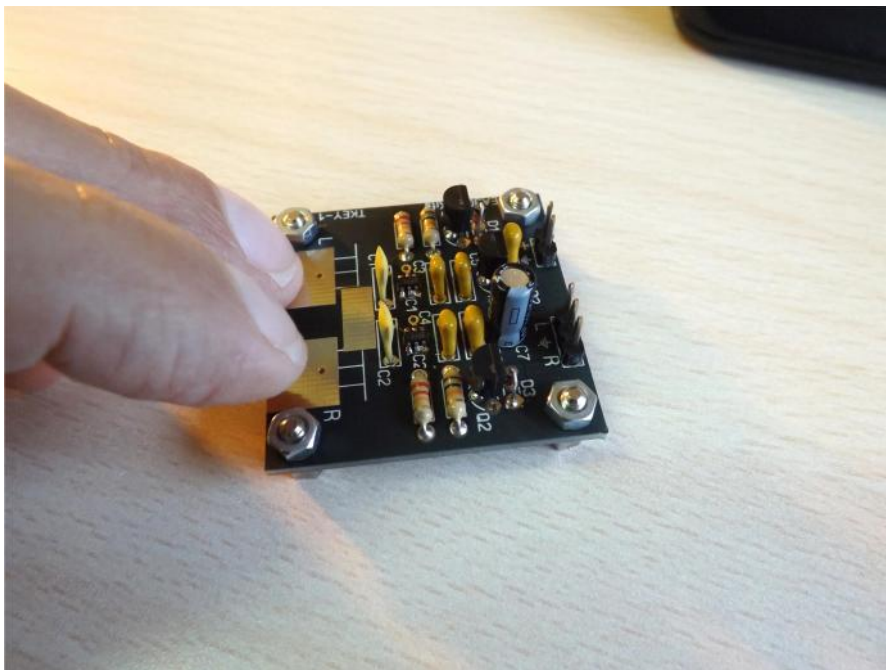

## CONNECTIONS

1.- Apply 6.5 to 15V power supply voltage to the header pins marked “+” and the symbol “GND” on the board. The circuit’s current consumption is very low (less than 2 mA) and can ideally use a battery pack or a single 9V battery.

2.- The key paddle outputs are on the pins marked “L” and “R” and the common or “ground” is the pin marked with the symbol “GND”.

You will need to prepare a suitable cable and connector for your equipment. Equipment normally uses a 3.5 or 5 mm diameter stereo jack. Theoretically the output of the TKEY-1 will work with 99.9% of the equipment on the market.

However, if you have a question regarding connection to your equipment, you may consult with EA3GCY kits by email at [ea3gcy@gmail.com](mailto:ea3gcy@gmail.com).

## ASSEMBLY OF THE PADDLES

When you are sure that your key is working correctly and you have decided how you are going to use it, you can solder the three pieces of PCB that make up the key paddles.

**You do not have to use the paddle system that is included in the kit; you can use your creativity and customize the type of paddles that you wish to use. Keep in mind that this circuit can be placed in many types of boxes and/or supports; it can be integrated with a transmitter of your own construction, etc.**

**If needed, you can use short pieces of cable (unshielded only) to connect the circuit to your custom paddles.**

**If you do a Google search, you will be able to see many ideas!**

The following work is easy, but you need to do it carefully and think about how you want the paddles positioned (how much separation between them) before soldering them in place.

Once they are soldered it is not easy remove them!



1.- With a drop of solder on each of the faces of the small piece of board that will connect to the two paddles, solder it to the main board. **Obviously, it is very important that it is as vertical as possible and centered on the main circuit board.**

There are lines printed on the circuit board to help you.

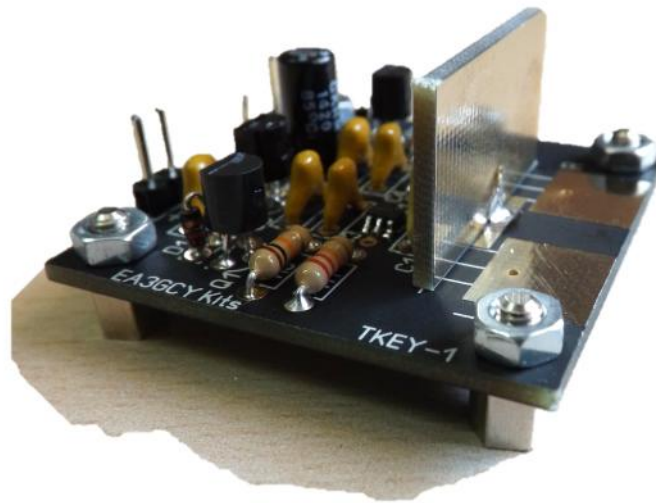

2.- Solder one of the paddles in its place (the two paddles are the same, because their two faces are the same).

You may choose the separation between the two paddles. There are lines printed on the circuit board to help you. Decide on the position before soldering and place the two paddles so that they are centered and totally vertical with respect to the main board.

As the photos show, the paddles are soldered to the main board and to the vertical board which functions as the back wall.

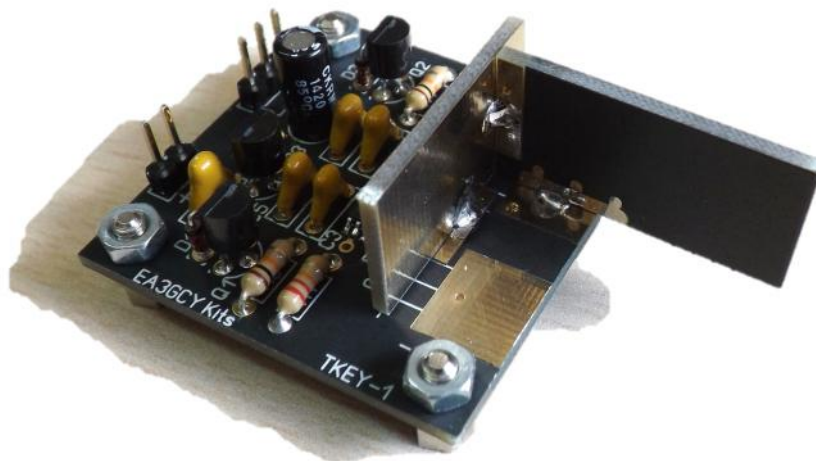

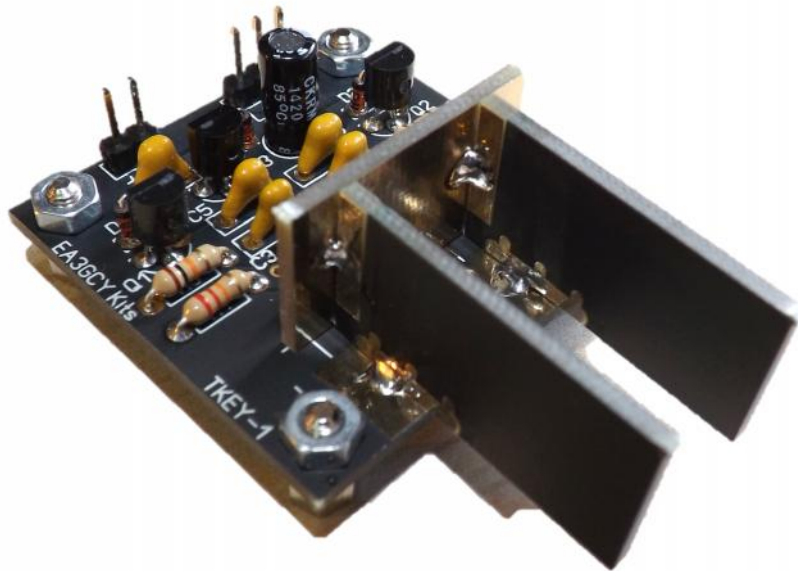

## INSTALLATION IN THE "TKEY-1 BOX"

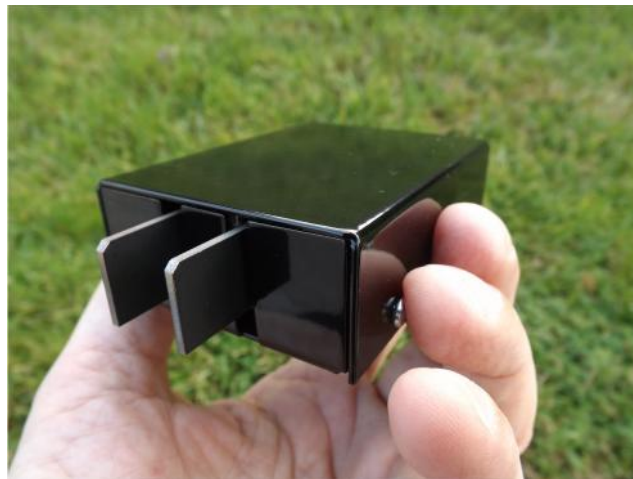

The most important thing to note is that the "TKEY-1 BOX" box incorporates a 3V power supply CR2032 battery. **You must not mount IC3 or D2 and instead you must place two bridges** as shown in the following image:





**Note:** The supplied "button" battery can deliver about 200mA and is suitable for working about 100 hours. If you are going to work a lot and everyday with the TKEY-1, it may be a good idea to use a 3.6V type LS14250 battery that can supply about 800-1200mA depending on the model).

## TKEY-1 BOX Wiring

With the TKEY-1 BOX kit, in addition to the box you will find:

Quantity	Part
1	ON/OFF Switch
1	Chassis socket Jack 3,5mm
1	CR2032 battery socket
1	3V CR2032 battery
10 cms	Red wire
10 cms	Black wire
5 cms	Green wire
4	M3 Hexa spacers
4	M3 Nuts
4	4mm Screws M3x4
4	5mm self tapping Screws

1.- Install the TKEY-1 board with spacers, screws and nuts. Install the 3.5mm jack socket, switch, 3V battery and socket as shown.

The battery socket is stuck with the double-sided adhesive tape already pre-installed.

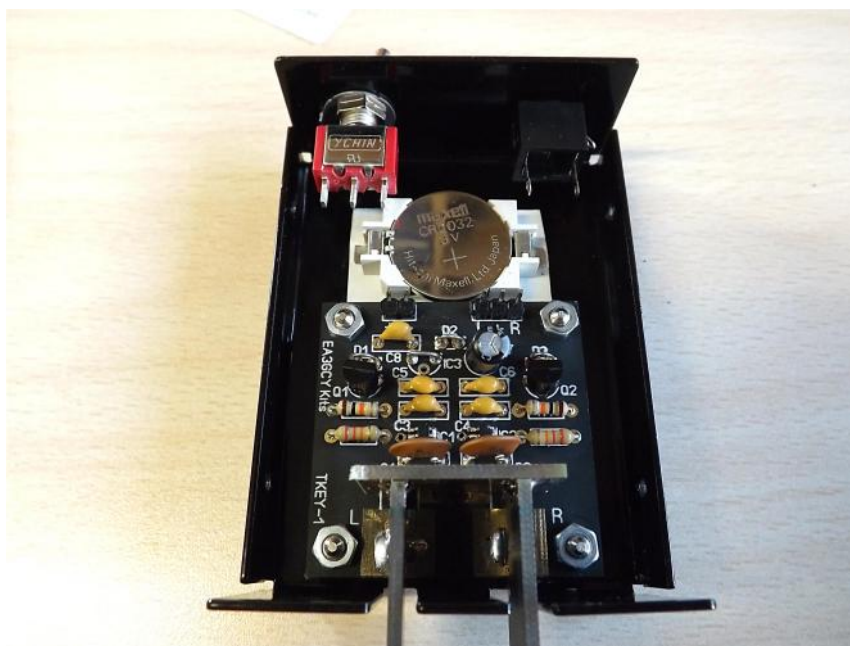

2.- Wire as shown in the pictures.



**Important:** Make sure that the entire housing (base and cover) contacts to negative pole (GND), scrape the paint around the screws (on the inside) to make electrical contact. This is very important to isolate the electronic circuit from the external RF field.

# HOW TO ADD AN INDICATOR LED "ON"

When you finish use TKEY-1, you should always remember to switch to "OFF". If it does not, the battery may run out in a few days.

To avoid this, it is a good option to install a power monitor LED.

You can use a small LED with a resistance of 1K or higher to consume as little as possible.

Remember: The long leg of the Led is positive and the short leg is negative.

The following images show you a way to install an "ON" LED.

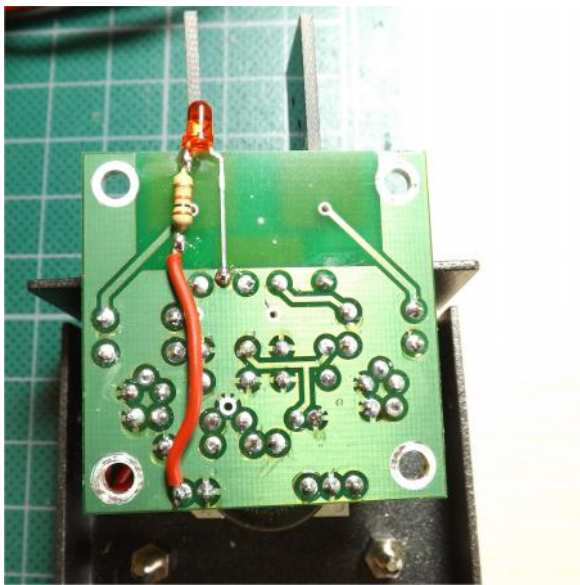

## LIMITED WARRANTY

### Please read carefully BEFORE building your kit

All electronic components and hardware supplied with the kit are under warranty in case of any manufacturing defect for the period of one year after purchase. The warranty does not include the transmitter final amplifier transistor.

The original purchaser has the option of examining the kit and manual for 10 days. If, within this period, the buyer decides not to build the kit, he/she may return the entire unassembled kit at their own expense for the shipping expenses. The shipping expenses and sales commissions (i.e. bank, Ebay, and Paypal commissions) included in the purchase price will not be returned.

Please, BEFORE returning a product, request instructions by email at: [ea3gcy@gmail.com](mailto:ea3gcy@gmail.com)

Javier Solans, EA3GCY, warrants this device to function according to the specifications, provided that it is assembled and adjusted as described in this documentation, and used correctly according to all provided instructions.

It is your responsibility to follow all the instructions in the manual, to identify all the components correctly, and to use good workmanship and proper tools and instruments in the construction and adjustment of this kit.

REMEMBER: This kit will not work as a commercially manufactured product; however, it can often give similar results. Do not expect great performance, BUT YOU ARE SURE TO HAVE LOTS OF FUN!

If you believe that there is a missing component for the kit, please do a thorough inventory of all parts using the parts list in the manual. Check all bags, envelopes and boxes carefully. If needed, you may email me and I will replace any component that you are missing. Even if you can find the exact part locally, please let me know so that we are aware of the problem to help other customers.

I can also supply any part that you have lost, damaged or broken accidentally.

If you find any errors in this manual or would like to make a comment, please do not hesitate to contact me at: [ea3gcy@gmail.com](mailto:ea3gcy@gmail.com)

THANK YOU for building the TKEY-1 kit.

Enjoy QRP!

73 Javier Solans, EA3GCV

## SCHEMATIC

